

Rotation "A" - (anticlockwise)

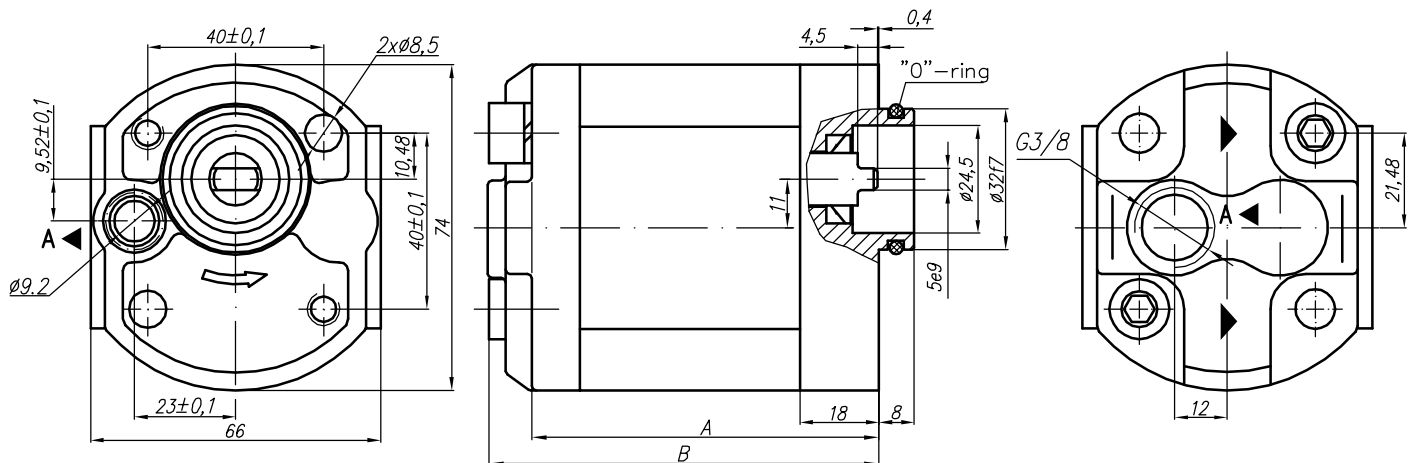

Rotation "C" - (clockwise)

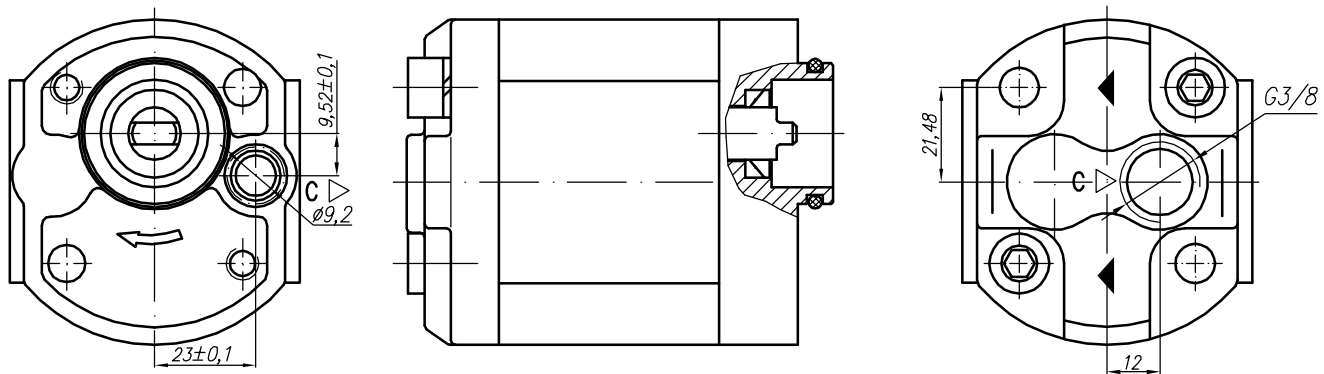

Type	Displacement cm ³ /rev	Flow		Pressure P _{nom} bar	max Speed n rpm	Dimension						
		at 1500 rpm l/min	at max rpm l/min			A mm	B mm	Inlet			Outlet	
								M	G	U		
10A(C)1X489	1	1,40	3,26	250	3500	71	81					
10A(C)1,25X489	1,25	1,74	4,07	250	3500	72	82					
10A(C)1,6X489	1,6	2,23	5,21	250	3500	73,6	83,6					
10A(C)2X489	2	2,82	6,58	250	3500	75,2	85,2					
10A(C)2,5X489	2,5	3,53	8,23	250	3500	77,2	87,2					
* 10A(C)2,65X489	2,65	3,74	8,72	250	3500	77,8	87,8					
10A(C)3,15X489	3,15	4,44	10,36	250	3500	79,8	89,8					
10A(C)3,65X489	3,65	5,15	12,01	250	3500	81,9	91,9					
10A(C)4,2X489	4,2	5,92	13,82	250	3500	84,1	94,1					
* 10A(C)4,7X489	4,7	6,63	15,46	250	3500	87,1	97,1					
10A(C)5X489	5	7,05	14,10	250	3000	87,2	97,2					
10A(C)5,7X489	5,7	8,12	16,25	200	3000	90,1	100,1					
10A(C)6,1X489	6,1	8,69	14,49	200	2500	91,8	101,8					
10A(C)7,4X489	7,4	10,55	17,58	180	2500	97,2	107,2					
* 10A(C)8X489	8	11,40	15,20	150	2000	99,7	109,7					
10A(C)8,5X489	8,5	12,11	16,15	150	2000	101,7	111,7					
10A(C)9,8X489	9,8	13,97	18,62	120	2000	107	117					

* - These pumps - only under a special order