

GENERAL DESCRIPTION

List: RH06-6F-1-Oct 2015

- ✓ 4/3- and 4/2- way directional control valves with pneumatic operation
- ✓ Reliability and long life
- ✓ Mounting surface CETOP3 (NG6)

RH06...6F...



The RH06...6F... valves consist of a spool, housing, springs and pneumatic control unit.

They are used to control the start, stop and direction of flow.

This model is designed with two-spring centered spool about 4/3- and 4/2- valves. The housing has 5-chambers.

The valve location during assembly is of minor importance, but the horizontal position is generally recommended.

For functional symbols "08", "19", "20" and "82", the horizontal position is obligatory.

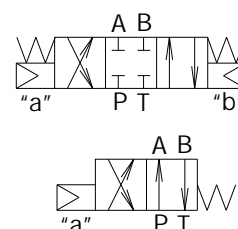
Symbol

ORDERING CODE

RH	06	...	6	F
----	----	-----	---	---	-----	-----	-----

Directional control valve

Nominal size

Functional symbol

see page 2/4

Type of control

- pneumatic

Modification

Spacers

Omit-Without spacers

S-with spacers

see page 3/4

Connection threads

M - M14x1,5

G - G1/4"

see page 3/4

Backing of the housing











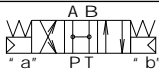
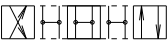

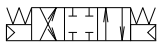
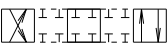

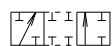

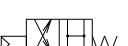



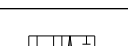
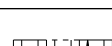
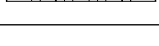

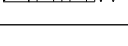
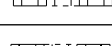
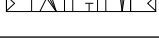
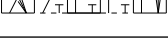
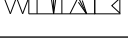
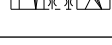
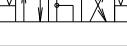

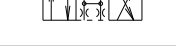

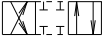
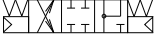

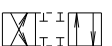
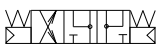
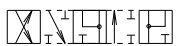

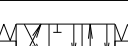
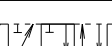
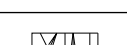
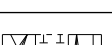
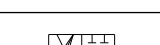
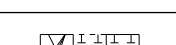
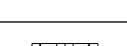
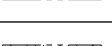
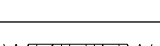
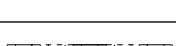
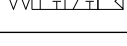

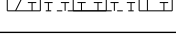
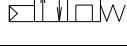

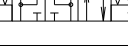
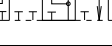
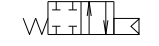
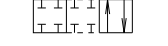
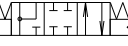
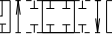

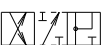

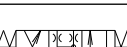
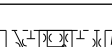
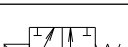
N - normal

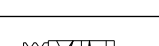
T - tropical

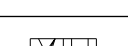
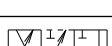
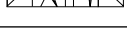
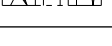
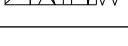
TECHNICAL DATA

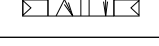
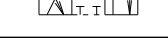
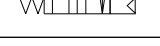
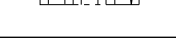
DATA	UNIT	VALUE/RANGE
Weight	-three positional -two positional	kg 1,950 1,450
Max. Pressure	port P, A & B port T	MPa 32 16
Rated flow	(at Dp=0,1MPa)	l/min 11...20
Pilot pressure	-P _{min} -P _{max}	MPa 0, 2 1

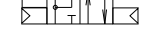
FUNCTIONAL SYMBOLS

DESIG-NATION	SYMBOL	INTERMEDIATE	DESIG-NATION	SYMBOL	INTERMEDIATE
00			28		
01			32		
02			33		
04			34		
05			36		
06			39		
08			40		
10			41		
11			42		
12			45		
13			52		
14			61		
16			62		
17			64		
18			68		
19*			70		
20*			78		
21			82*		
24			83		
26			98		
27			99		

* Symbols 19 , 20 and 82 are with detent. Both switched positions are alternately fixed. Other symbols on request.

DIMENSIONS

All dimensions are shown in mm.

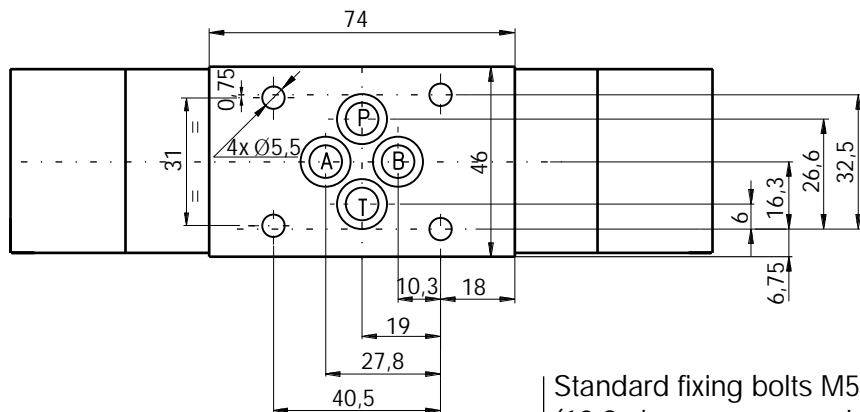

Symbols 00 , 01 , 02 , 04 , 05 , 06 , 08 , 18 , 19 , 20 , 21 , 26 , 40 , 41 , 42 , 52 , 61 , 62 , 82 , 98 , 99

Standard fixing bolts M5x30 (10,9 class recommended). Torque- 6...8 Nm. In case of modular mounting spacers are available upon order - see "ORDERING CODE" - code S.

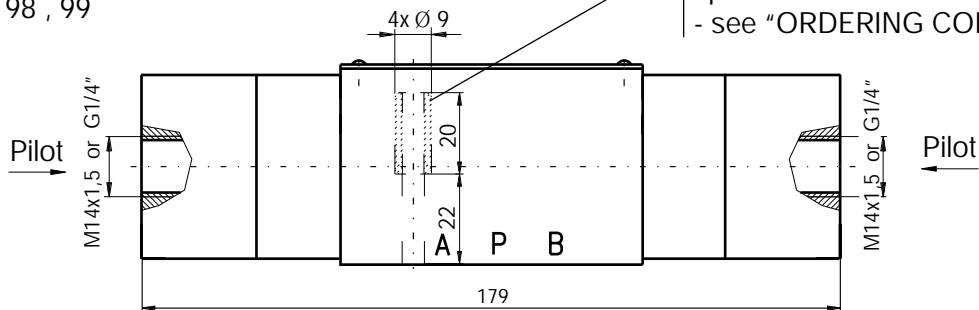

Symbols 11 , 12 , 14 , 17 , 24 , 27 , 33 , 34 , 39 , 45 , 68 , 70 , 83

Symbols 10 , 13 , 16 , 28 , 32 , 36 , 64 , 78

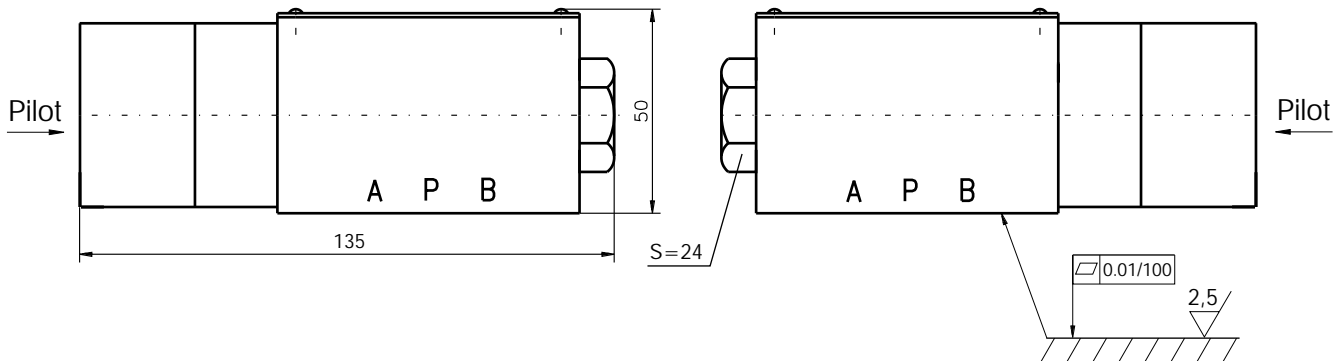

SEALS

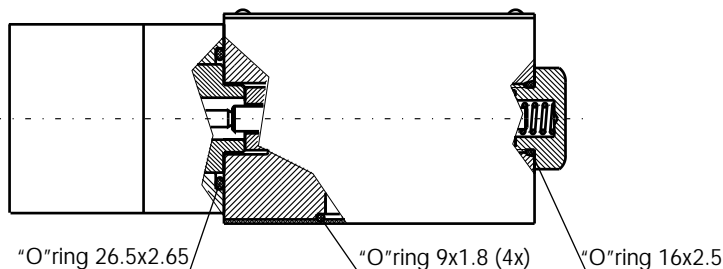

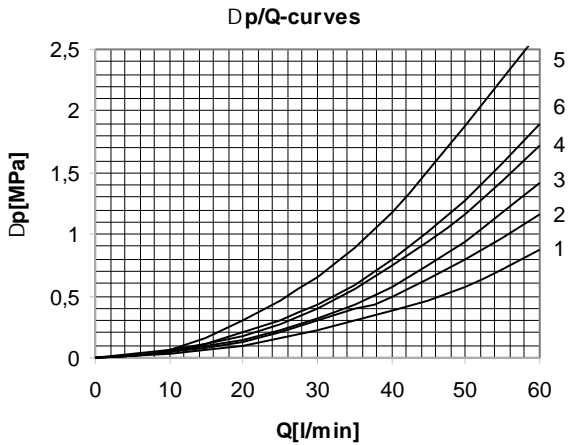
CHARACTERISTICS
Dp/Q

SYMBOL	CURVE					SYMBOL	CURVE				
	P>A	P>B	A>T	B>T	P>T		P>A	P>B	A>T	B>T	P>T
00	2	2	1	1	3	28	3			1	
01	2	2	1	1		32	3	3			
02	5	5	5	5	4	33		2	1		3
04	3	3	1	1		34	1				
05	2	2	2	2		36	1	1	2	3	
06	3	3	3	3	4	39	1	1	3	2	
08	2	2	1	1		40		4	6		
10	3	4	3	2		41		4	1		
11	2	2	1	1		42	3	2	1	2	
12	4	3	2	3		45		2	1		
13	2	2				52	1	1			
14	5			5	4	61	4			1	
16	2			1		62	4			6	
17		2	2			64	2			1	
18	2	2	1	1		68	3	3			
19	2	2	2	2		70	3	2	1	2	
20	3	3	2	2		78	1			2	4
21(mid./end)	2/1	3	3	3		83		2	1		
24		3	1			99	2			2	4
26	3	2	1	2							
27	2			1							

p/Q

The operating limit of hydraulic power shown here is for applications with two directions of flow (e.g. from P to B and simultaneously from A to T). If the valve is with one direction passage only (e.g. from P to B and with blocked port A), the operating limit may considerably be reduced. The performance limits are measured with hydraulic oil 35 ± 5 cSt, temperature 50°C .

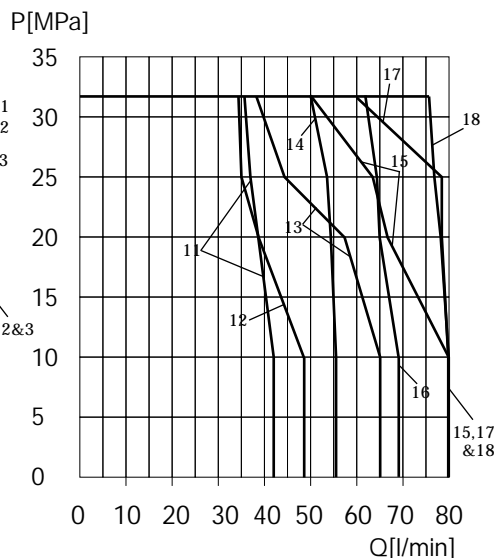
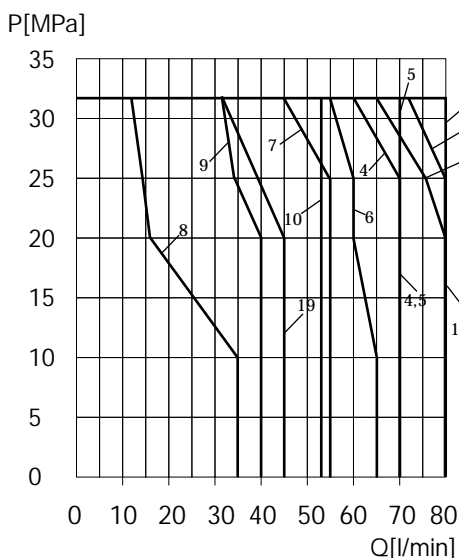

SYMBOL	CURVE	SYMBOL	CURVE
00	1	28	3
01	1	32	8
02	19	33	1
04	3	34	1
05	4	36	9
06	7	39	9
08	5	40	18
10	5	41	17
11	14	42	15
12	5	45	1
13	6	52	12
14	19	61	17
16	1	62	18
17	4	64	1
18	1	68	8
19	16	70	15
20	2	78	11
21	10	82	
24	3	83	1
26	15	98	
27	1	99	13